

222 Remington

Test Specifications:

Firearm Used: Universal

Barrel Length: 24"

Twist: 1-10"

Components:

Case: Norma

Trim-to Length: 1.690"

Primer: WSR

Remarks:

Remington introduced the 222 in 1950 in their Model 722 bolt-action rifle. The 222 was the first new cartridge to appear after WWII, and is an original case not based on an earlier existing head size. Designed by Remington's Mike Walker, a noted benchrest shooter, the 222 soon dominated the benchrest game. It maintained its superiority for two and a half decades, until the 22 and 6mm PPCs dethroned it. As is so often the case, the 222 produced its own "family" of offspring, including the 17 Remington, 221 Fireball, 223 Remington, and 222 Remington Magnum.



We have always found the 222 to be an extremely easy cartridge to load. Although it rarely shows a prejudice for any particular powder of the appropriate burning rate. The list of excellent powder and bullet combinations is certainly mind boggling.

For varmint hunting, especially in settled areas, the 222 is best served by the Blitz and BlitzKing bullets. Both sport a thin jacket, designed to expand readily at the 222's velocity levels. In most factory rifles, a 1x14" twist is standard. This twist normally gives best accuracy with bullets of 55 grains or less.

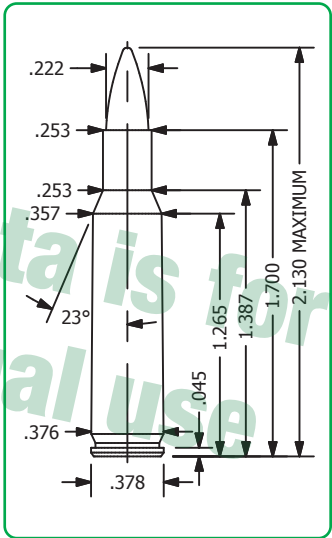

With the military adoption of the 223 Remington and the near total movement of benchrest crowds to the 6mm PPC, the "deuce" has lost much of its earlier support. It is still an extremely useful cartridge, and will no doubt see active use as a varmint cartridge for many years to come. At one time or another, the 222 has been chambered in a variety of action types by most arms manufacturers. The fact that it still remains a popular chambering in custom-built rifles is strong testimony to its effective field performance and superb accuracy.



22Z REMINGTON





	Bullet	Caliber	Weight	Type	C.O.A.L.			
	#1200	.224"	40gr.	Hornet	2.130"			
	#1385	.224"	40gr.	HP	2.130"			
	#1440	.224"	40gr.	BlitzKing	2.130"			
Powder	Velocity	2950	3050	3150	3250	3350	3450	3500
A 1680					19.0	19.9		
RE 7		19.8	20.4	21.0	21.6	22.1		
IMR 4198		19.1	19.9	20.5	21.1			
H322			22.4	22.9	23.7	24.6	25.1	
LT 32			21.3	22.0	22.8	23.8		
A 2015			21.8	22.4	23.0	23.7		
N130	18.8	19.2	19.7	20.3	21.0			
Benchmark			22.8	23.4	24.2	25.2		
Exterminator		22.2	23.0	23.7	24.3	24.8	25.0	
Energy Ft. Lbs		773	826	881	938	997	1057	1088
Special Load	Powder	Grains	Velocity fps	Energy Ft. lbs				
Accuracy Load	N130	21.0	3350	997				
Hunting Load	H322	25.1	3500	1088				

22Z Remington









	Bullet	Caliber	Weight	Type						C.O.A.L.
	#1210	.224"	45gr.	Hornet						2.050"
	#1310	.224"	45gr.	SPT						2.130"
Powder	Velocity	2700	2800	2900	3000	3100	3200	3300		
RE 7					19.1	20.0	20.8			
IMR 4198				18.6	19.2	19.8				
H322	19.5	20.2	20.9	21.6	22.3	22.9				
LT 32			19.7	20.5	21.3	22.1				
A 2015	19.3	20.0	20.8	21.4	22.1					
N130	16.4	17.3	18.1	18.9	19.6	20.3				
Benchmark	19.7	20.4	21.0	21.7	22.4	23.1	23.8			
Exterminator		20.1	21.0	21.9	22.6	23.3	23.8			
Energy Ft. Lbs		728	783	840	899	960	1023	1088		
Special Load	Powder	Grains		Velocity fps		Energy Ft. lbs				
Accuracy Load	IMR 4198	19.8		3100		960				
Hunting Load	Benchmark	23.8		3300		1088				

Do not edit or redistribute.

7ZZ REMINGTON

		Bullet	Caliber	Weight	Type	C.O.A.L.		
		#1320	.224"	50gr.	SMP	2.100"		
		#1330	.224"	50gr.	SPT	2.130"		
		#1340	.224"	50gr.	Blitz	2.130"		
		#1450	.224"	50gr.	BlitzKing	2.130"		
Powder	Velocity	2600	2700	2800	2900	3000	3100	3200
RE 7		17.6	18.4	19.1	19.8	20.5		
IMR 4198		17.5	18.1	18.7	19.3			
H322		19.2	19.8	20.4	21.0	21.7	22.4	
LT 32			18.6	19.6	20.4	21.0	21.4	
A 2015		19.2	19.8	20.4	21.1	21.7		
RE 10x				19.1	19.7	20.4	21.0	
N130			17.2	17.9	18.6	19.3	19.9	
Benchmark		19.6	20.3	21.0	21.6	22.3	23.0	
Exterminator		19.5	20.2	20.9	21.6	22.3	23.0	
Power Pro Varmint		20.5	21.2	21.8	22.5	23.3	24.0	
Energy Ft. Lbs		750	809	870	934	999	1067	1137
Special Load	Powder	Grains	Velocity fps	Energy Ft. lbs				
Accuracy Load	Benchmark	23.0	3100	1067				
Hunting Load	RE 7	20.5	3100	1067				

222 Remington

	Bullet	Caliber	Weight	Type	C.O.A.L.
	#1410	.224"	52gr.	HPBT Match	2.210"
	#1400	.224"	53gr.	HP Match	2.230"
	#1345	.224"	55gr.	Blitz	2.130"
	#1350	.224"	55gr.	SMP	2.130"
	#1355	.224"	55gr.	FMJBT	2.130"
	#1360	.224"	55gr.	SPT	2.130"
	#1365	.224"	55gr.	SBT	2.130"
	#1390	.224"	55gr.	HPBT	2.120"
	#1455	.224"	55gr.	BlitzKing	2.130"*



*55 grain BlitzKing requires a 1x12" or faster twist

Powder	Velocity	2450	2550	2650	2750	2850	2950	3000
RE 7			17.2	17.9	18.6	19.2	19.8	
IMR 4198	16.1	16.8	17.5	18.1	18.8			
H322		18.8	19.4	20.0	20.8	21.6	22.0	
A 2015	18.1	18.8	19.5	20.1	20.7			
RE 10x	17.1	17.7	18.3	18.9	19.6	20.4		
N130		16.6	17.4	18.1	18.8			
Benchmark		19.4	20.0	20.7	21.4	22.1	22.5	
Exterminator			20.1	21.1	21.9	22.6	22.9	
Power Pro Varmint		20.6	21.3	22.1	22.7	23.3	23.6	
Energy Ft. Lbs		693	751	811	873	938	1005	1039

Special Load	Powder	Grains	Velocity fps	Energy Ft. lbs
Accuracy Load	N130	18.8	2850	938
Hunting Load	H322	22.0	3000	1039

Sierra does not recommend MatchKing bullets for hunting applications.

7ZZ REMINGTON

	Bullet	Caliber	Weight	Type	C.O.A.L.				
	#1375	.224"	60gr.	HP	2.130"				
	#7160	.224"	60gr.	TMK	2.130"*				
	#1370	.224"	63gr.	SMP	2.130"				
*60 grain TMK requires a 1x10" or faster twist									
Powder	Velocity	2300	2400	2500	2600	2700	2800	2900	
RE 7				16.8	18.5	19.3			
H322			18.2	18.8	19.6	20.4	21.3		
A 2015	17.8	18.6	19.4	20.1	20.9				
RE 10x		17.2	18.0	18.8	19.5				
N130		15.8	16.6	17.5					
Benchmark		18.5	19.1	19.7	20.5	21.3			
Exterminator		19.1	19.8	20.5	21.4	22.2			
Power Pro Varmint			20.5	21.6	22.6	23.3	23.7		
Energy Ft. Lbs		705	767	833	900	971	1044	1120	
Special Load	Powder	Grains	Velocity fps	Energy Ft. lbs					
Accuracy Load	H322	21.3	2800	1044					
Hunting Load	Power Pro Varmint	23.7	2900	1120					