

357 Remington Magnum

Test Specifications:

Firearm Used: Universal

Barrel Length: 5.64"

Twist: 1-10"

Components:

Case: Starline

Trim-to Length: 1.285"

Primer: WSPM

Remarks:

The .357 Magnum is the oldest and most popular of our modern magnum revolver cartridges. Introduced in 1935, the .357 Magnum came about as a result of work done by Phil Sharpe, using extremely heavy loadings in a pair of .38/44 Outdoorsman revolvers. Sharpe, a respected gun writer of the period, had the chance to demonstrate the effectiveness of these loads during a hunting trip with Colonel Douglas B. Wesson, then vice-president of Smith & Wesson. While Sharpe modestly declined to take credit for the new cartridge, Col. Wesson was highly impressed. Plans were made to introduce a new revolver built around the new round, now known as the .357 Magnum. Winchester collaborated in this effort, producing a case some .135" longer than the .38 Special. The .357 achieves its increased performance by a tremendous increase in operating pressure. At the time of its introduction, the .357 Magnum was the most powerful commercial cartridge ever chambered in a revolver, an honor it retained until being upstaged by the .44 Magnum some twenty years later.

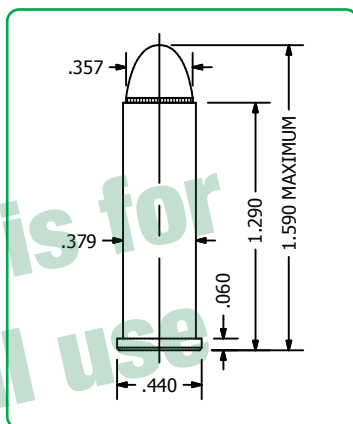

The .357 is a tremendously versatile cartridge. It offers an excellent balance of stopping power and controllable recoil. While the .357 is at its best with large charges of slow burning powders, it is an easy cartridge to load for. Faster burning powders, such as Unique and 231 allow much milder loads to be used for practice and plinking. In addition to the lighter .357 Magnum loads, standard .38 Specials can be fired in any .357 revolver as well. The .357 is an excellent all-around cartridge, and will undoubtedly remain with us for many years to come.



357 Remington Magnum

Bullet		Caliber	Weight	Type	C.O.A.L.					
		#8300	.357"	110gr.	JHP	1.575"				
Powder	Velocity	1250	1350	1450	1550	1650	1750	1800		
Clays				7.2	7.9					
Bullseye				7.6	8.4	9.2				
Tite Group			6.7	7.5	8.3					
American Select			7.0	7.8						
WST			7.1	7.9						
BE 86					9.6	10.4	11.2			
Zip			8.0	8.8	9.5	10.2				
Win 231			7.9	8.6	9.3					
Unique			7.8	8.5	9.3					
Universal				8.2	9.0	9.8				
Power Pistol				9.0	9.8	10.6	11.5			
N330		7.4	8.1	8.8	9.5					
True Blue					10.6	11.4				
A#5		9.2	10.1	11.0	11.9	12.8				
Auto Comp				9.4	10.2	11.0				
CFE Pistol				9.1	9.9	10.7				
Win 572						11.1	11.7			
A#9						17.2	17.8	18.1		
3N38						13.1	13.7			
Energy Ft. Lbs		382	445	513	587	665	748	791		
Special Load	Powder	Grains	Velocity	fps	Energy	Ft. lb				
Accuracy Load	Power Pistol	11.5	1750		748					
Hunting Load	A#9	18.1	1800		791					



357 REMINGTON MAGNUM

Bullet		Caliber	Weight	Type	C.O.A.L.				
	#8310	.357"	125gr.	JSP	1.585"				
	#8320	.357"	125gr.	JHP	1.585"				
Powder	Velocity	1200	1300	1400	1500	1600	1650	1700	
Tite Group		6.7	7.4						
American Select		6.3	7.0	7.8					
WST			7.2	8.0					
BE 86					9.5	10.4	10.8		
Unique				8.2	9.3				
Universal				8.4	9.1				
Power Pistol					9.6	10.4	10.9		
N330		7.4	8.0	8.6					
True Blue				9.6	10.5	11.4			
A#5					11.4	12.3			
Auto Comp				9.3	10.1	10.9			
Win 572				9.2	9.8	10.5	10.8		
Longshot				9.3	10.0	10.7			
A#9					15.4	16.1	16.4	16.7	
3N38				10.9	11.5	12.2	12.6		
H110					18.4	19.5	20.0	20.6	
Power Pro 300 MP						20.1	20.7	21.4	
Energy Ft. Lbs		400	469	544	624	710	756	802	
Special Load	Powder	Grains	Velocity	fps	Energy	Ft. lb			
Accuracy Load	True Blue	11.4	1600		710				
Hunting Load	A#9	16.7	1700		802				

357 REMINGTON MAGNUM

		Bullet Caliber Weight Type							C.O.A.L.
		#8325 .357" 140gr. JHP							1.575"
Powder	Velocity	1100	1200	1300	1400	1500	1600	1700	
Bullseye			6.4	7.1					
Tite Group			6.4	7.0					
American Select		6.1	6.6						
WST		6.1	6.6						
BE 86				7.9	8.8	9.6			
Zip			7.5	8.2					
Win 231			7.2	7.9					
Universal			7.1	7.8	8.4				
Power Pistol				8.2	9.0	9.8			
N330			7.1	7.8					
True Blue					9.5	9.9			
A#5				10.2	10.5	10.9			
Auto Comp			7.7	8.5	9.3				
CFE Pistol			7.5	8.3	9.1				
Win 572				8.2	9.0				
A#7				11.3	11.9	12.5			
Longshot					9.2	10.1			
A#9					13.2	14.2	15.2		
3N38				9.7	10.4	11.1			
Win 296							19.0	20.2	
IMR 4227					18.1	19.5			
Power Pro 300 MP							19.1	20.4	
Energy Ft. Lbs		376	448	525	609	699	796	898	
Special Load	Powder	Grains	Velocity fps	Energy Ft. lb					
Accuracy Load	3N38	11.1	1500	699					
Hunting Load	Win 296	20.2	1700	898					

357 REMINGTON MAGNUM

		Bullet	Caliber	Weight	Type						C.O.A.L.
		#8340	.357"	158gr.	JSP						1.585"
		#8360	.357"	158gr.	JHC						1.585"
Powder	Velocity	1000	1100	1200	1300	1400	1450	1500			
Bullseye		5.5	6.4								
Tite Group		5.4	6.3								
WST		5.2	6.0								
BE 86			7.2	8.0							
Zip		6.4	7.2								
Win 231		6.2	7.0								
Unique		6.1	6.9								
Universal			7.0	7.8							
Power Pistol			7.2	8.1							
N340		6.4	7.2								
True Blue			7.9	8.9							
A#5			8.7	9.6							
Auto Comp			7.5	8.4							
CFE Pistol			7.1	8.0							
N350		6.9	7.6								
Win 572			7.3	8.2							
Longshot			7.3	8.2							
2400				12.7	13.4	13.8					
Enforcer				13.2	14.4	15.0	15.6				
A#9				12.1	13.0	13.4					
3N38			8.8	9.5							
N110				12.5	13.6	14.2					
H110						15.6	16.4				
Win 296					15.2	15.9	16.6				
IMR 4227				15.0	16.4						
Power Pro 300 MP						16.5	17.1				
Energy Ft. Lbs		351	424	505	593	688	737	789			
Special Load	Powder	Grains	Velocity fps	Energy Ft. lb							
Accuracy Load	A#5	9.6	1300	593							
Hunting Load	Enforcer	15.6	1500	789							

357 REMINGTON MAGNUM

		Bullet Caliber Weight Type								C.O.A.L.
		#8350	.357"	170gr.	FMJ Match					1.585"
Powder	Velocity	900	1000	1100	1200	1300	1400	1500		
Tite Group			4.9	5.8						
WST	4.7		5.4							
Zip				6.5	7.3					
Win 231			5.5	6.3						
Universal				6.4	7.1					
N340			5.9	6.6						
True Blue				7.3	8.2					
A#5				7.9	8.8	9.7				
Auto Comp				6.9	7.7					
CFE Pistol				6.7	7.4					
N350				7.1	7.9					
Win 572			6.0	6.8	7.5					
Longshot				6.7	7.5	8.4				
Enforcer						13.2	14.3	15.4		
A#9						11.9	12.9			
3N38				8.1	8.8	9.5				
Lil Gun							15.3	16.7		
H110						14.0	15.2			
Win 296						14.0	15.2			
IMR 4227				13.5	14.9	16.3				
Power Pro 300 MP						14.2	15.5	16.9		
Energy Ft. Lbs		306	377	457	543	638	740	849		
Special Load	Powder	Grains	Velocity fps	Energy Ft. lb						
Accuracy Load	Zip	7.3	1200	543						
Hunting Load	Enforcer	15.4	1500	849						

357 REMINGTON MAGNUM

Bullet Caliber Weight Type		C.O.A.L.						
	#8370 .357" 180gr. FPJ Match	1.585"						
Powder ▾	Velocity >	850	950	1050	1150	1250	1350	1400
Tite Group			4.9	5.5				
WST	4.5		5.2					
Zip			5.6	6.3				
N340			5.7	6.4				
True Blue				7.0	7.9			
A#5				7.6	8.5			
CFE Pistol			5.7	6.4	7.2			
Longshot				6.5	7.3			
3N38			7.3	7.9	8.5			
Win 296							14.8	15.4
Energy Ft. Lbs		289	361	441	528	624	728	783
Special Load	Powder	Grains	Velocity fps	Energy Ft. lb				
Accuracy Load	Win 296	15.4	1400	783				
Hunting Load	Win 296	15.4	1400	783				

Do not edit or redistribute.